

NEW LEON



CUPRA

INDEX

06



BEAUTY

EXTERIOR STYLING
INTERIOR STYLING
COLOURS
WHEELS
INTERIOR AMBIENTS

POWER

CUPRA LEON
SPORTSTOURER
EFFICIENCY AMPLIFIED



24

50



TECHNICALS

STANDARD & OPTIONAL
EQUIPMENT
ENGINE SPECS

30



INNOVATION

CUPRA CONNECT
TECHNOLOGY
SAFETY
UPGRADES

LEISURE

ACCESSORIES
CUPRA e-CARE
ENVIRONMENTAL
INFORMATION



42



AN UNBREAKABLE THREAD TIES YOU TO YOUR DESTINY.

THIS THREAD TURNS YOUR IDEAS INTO A PULSE OF INTENSE EMOTIONS, DRIVING YOU TOWARD THE FINISH LINE—A JOURNEY BOUND BY PASSION. IT IS HERE THAT THE SOUL IS IGNITED AT EVERY TURN. THIS ISN'T JUST A DESIRE; IT'S THE MAGNETIC FIELD OF YOUR WILDEST VISION. AN ATTRACTION SO STRONG THAT YOU CAN'T HELP BUT EMBRACE IT. THIS IS THE POWER OF ATTRACTION, THE DRIVING FORCE BEHIND ANY SUCCESSFUL JOURNEY.





BEAUTY

Attraction is the catalyst for beauty, the prelude to admiration. Just like a symphony that captures all of your senses, leaving nothing but you and the resounding harmony. In it lies this craft: each detail, each sensation, everything is a testament to beauty in motion. For us, this is about you, the driver. Although your emotions can sometimes distract you, we strive to transform them into a driving force that keeps you moving forward.

Our global range of cars and product specifications varies from country to country. Please, visit your local CUPRA website to know more about the product offer available for you.



EXTERIOR STYLING CUPRA LEON

FRONT BUMPER REVOLUTION

Explore a reimagined front-end with redesigned air intakes, featuring a new bumper and grille with an integrated logo for a sleek, powerful statement.



A NEW PATH AHEAD

The 19" Hailstorm forged wheels complemented by performance brakes, delivering exceptional braking efficiency, and ensuring every journey is smoother, sharper, and more precise.



INTUITIVE LIGHT REVEALED

Illuminate your path with CUPRA integrated infinite light, enhancing your visibility with our organic 3D logo design and adaptive beams.





EXTERIOR STYLING CUPRA LEON SPORTSTOURER

BRING THE ROAD CLOSER

Embodies pure power fused with the latest tech. With its robust engines, autonomous drive features, and available CUPRA Matrix LED Lights, it assures a dynamic and sporty ride and a thrilling and memorable journey.



BEAUTY



SPORTY AND MORE

For those who demand a sporty performance. Experience thrilling enhancements with increased horsepower and extended electric range that ensure an exhilarating journey. Offering up to 1650 liters of boot space, this vehicle is designed for you to pack more and explore further.



INTERIOR STYLING

12.9" TOUCH SCREEN: BIGGER SIZE, BEST EXPERIENCE

Our 12.9" touch screen system combines tactile feedback with illuminated commands for a vivid display. You can easily access the information you need in three panels.



BEAUTY

Our global range of cars and product specifications varies from country to country. Please, visit your local CUPRA website to know more about the product offer available for you.



THE INTUITIVE CONSOLE

Newly redesigned console and dashboard with parametric design and advanced functions. A parametric moulding surface enhances the tactile and visual quality of the instrument panel.



AMBIENT ELEGANCE

The interior ambient lighting creates an atmosphere of sophistication, enveloping your dashboard, door panels, and interior spaces in adjustable colours for every mood. It offers soft, customizable illumination that transforms the cabin space.





COLOURS



←
NEW CENTURY BRONZE MATT⁴
VZ



→
NEW ENCELADUS GREY MATT⁴
VZ

→
MAGNETIC TECH MATT⁴
L VZ



←
NEW TAIGA GREY³
L VZ

CUPRA Leon	L
CUPRA Leon VZ	VZ
Standard	■
Optional	■

¹ Soft
² Metallic
³ Special Metallic
⁴ Matt



←
GRAPHENE GREY³
L VZ

→
MIDNIGHT BLACK²
L VZ



→
GLACIAL WHITE²
L VZ



→
MAGNETIC TECH²
L VZ



←
NEW FIORD BLUE¹
L VZ

CUPRA Leon	L
CUPRA Leon VZ	VZ
Standard	■
Optional	■

¹Soft
²Metallic
³Special Metallic
⁴Matt



WHEELS

→
19" HAILSTORM COPPER
VZ



→
19" POLAR COPPER
VZ L



←
19" POLAR
VZ L



←
19" HAILSTORM
VZ



BEAUTY

CUPRA Leon	L
CUPRA Leon VZ	VZ
Standard	■
Optional	■

Our global range of cars and product specifications varies from country to country. Please, visit your local CUPRA website to know more about the product offer available for you.



→
19" MISTRAL COPPER
VZ L



→
18" GARBI
L



←
19" MISTRAL
VZ L



←
18" WINDSTORM
L VZ



←
18" GARBI COPPER
L VZ



INTERIOR AMBIENTS



**EXTREME
CUP BUCKET SEATS**
■ VZ



**DYNAMIC DESIGN
BUCKET SEATS**
■ L ■ VZ

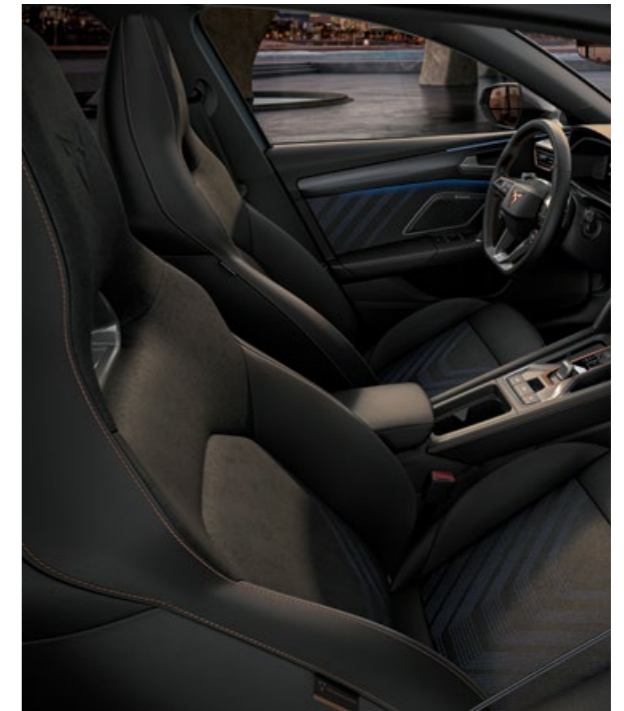

**PROGRESSIVE DESIGN
BUCKET SEATS**
■ L ■ VZ



SHARP
■ L



- L CUPRA Leon
- VZ CUPRA Leon VZ
- Standard
- Optional



POWER

They say there's a virtuous circle where a strong drive leads to a powerful destiny. But what is it about this powerful drive that seems so inviting? It's like the magnetic pull of masterful engineering—a force so captivating, one must not leave. Within lies the essence of driving: a desire to command the road with an energy so electrifying that there is no other choice but to start the car and press the accelerator.

Our global range of cars and product specifications varies from country to country. Please, visit your local CUPRA website to know more about the product offer available for you.



CUPRA LEON SPORTSTOURER

THE HIGHEST PERFORMING SPORTSTOURER

CUPRA's most powerful Sportstourer with Torque Splitter yet combines unrivaled power and agility with a sleek exterior design, featuring logo-incorporated rear lights and an expanded boot capacity.



POWER



AN UNRIVALED TORQUE SPLITTER

Through multi-disc clutches, the Torque Splitter distributes torque independently to each rear wheel, enhancing traction and handling. When engaged in "Drift" mode, the Torque Splitter maximizes rear axle slippage even with 4Drive all-wheel drive, ensuring dynamic driving.



Our global range of cars and product specifications varies from country to country. Please, visit your local CUPRA website to know more about the product offer available for you.



EFFICIENCY AMPLIFIED

Discover the flexibility of CUPRA's innovative charging solutions, created for both public and home use. With the My CUPRA app, you hold the power to manage your charging remotely, right from your palm.

E-HYBRID: PICK YOUR POWER

Experience the CUPRA Leon e-HYBRID, offering complete freedom to switch between pure gasoline power and full electric drive.



PUBLIC CHARGING ACCESSIBILITY

Recharge your Leon easily with a growing network of charging stations in city centres, suburbs and beyond. Using the My CUPRA app, you can effortlessly control remote charging, stay informed with real-time insights and authorize public chargers whenever you need.

HOME CHARGING SOLUTIONS

Enjoy convenience with CUPRA's home charging solutions via the My CUPRA app. Remotely manage your charging, oversee your home charger and be always ready to go.

CUPRA CHARGER 2

The CUPRA Charger Connect 2 ensures your Leon is powered swiftly and safely, covering the maximum charging capacity of your CUPRA up to 11kW AC*, without overloading your home's electrical system thanks to our chargers advanced technology.

* The Charger is able to reach powers of up to 22kW covering the maximum charging power of your CUPRA.



INNOVATION

Innovation is challenging the status quo with cutting-edge technology. For us this is a declaration of independence from the ordinary, embracing change as a journey to excellence. This model is a testament to those who dare to be different, merging advanced tech with thrilling performance. Claim your place in the driver's seat and steer towards a future where every drive is an extraordinary experience.



Our global range of cars and product specifications varies from country to country. Please, visit your local CUPRA website to know more about the product offer available for you.



CUPRA CONNECT

The pinnacle of integrated driving is CUPRA CONNECT, melding the 12.9" Navigation System's online capabilities to journey through life with real-time maps, entertainment, and voice commands, while enjoying the ability of finding and paying for parking from your own car with Park & Pay.

MY CUPRA APP

With My CUPRA app, remote access to your vehicle is effortless, offering control and monitoring for a smarter driving lifestyle.



CUPRA CONNECT

Gain peace of mind with CUPRA CONNECT, ensuring you're always just a call away from assistance.

CUPRA CONNECT PLUS

Stay ahead with CUPRA CONNECT PLUS, providing traffic updates, parking or petrol aids and charging solutions for a truly connected drive.



TECHNOLOGY



CUPRA MATRIX LED VISION

The CUPRA Matrix LED lights not only improve safety and visibility, but also welcome you with a symbolic illumination each time you unlock your car. This makes every approach an occasion, and you the honored guest of your own vehicle.



IMMERSIVE BY SENNHEISER™

Surrender to the acoustic brilliance of Immersive by Sennheiser™, with a symphony of 11 speakers plus one subwoofer surrounding you in sensational soundscapes.

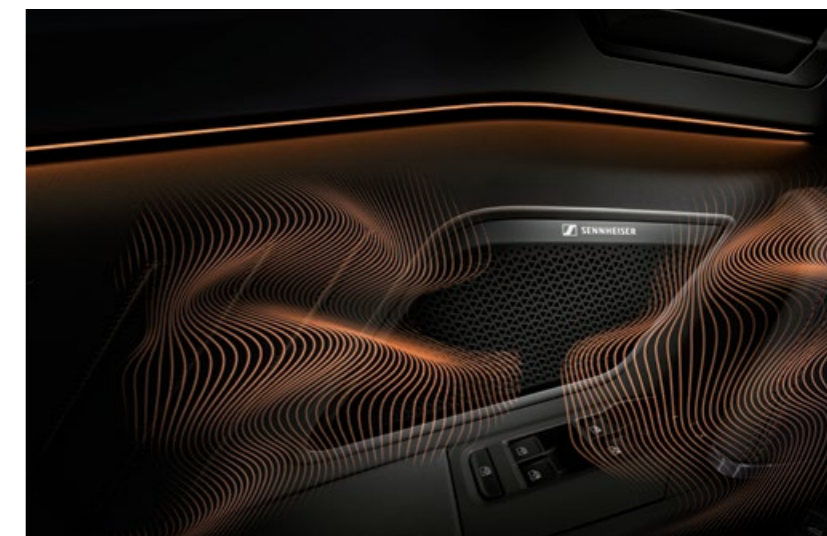

INTELLIGENT PARK ASSIST PRECISION

Intelligent Park Assist makes every parking manoeuvre a showcase of precision and ease.

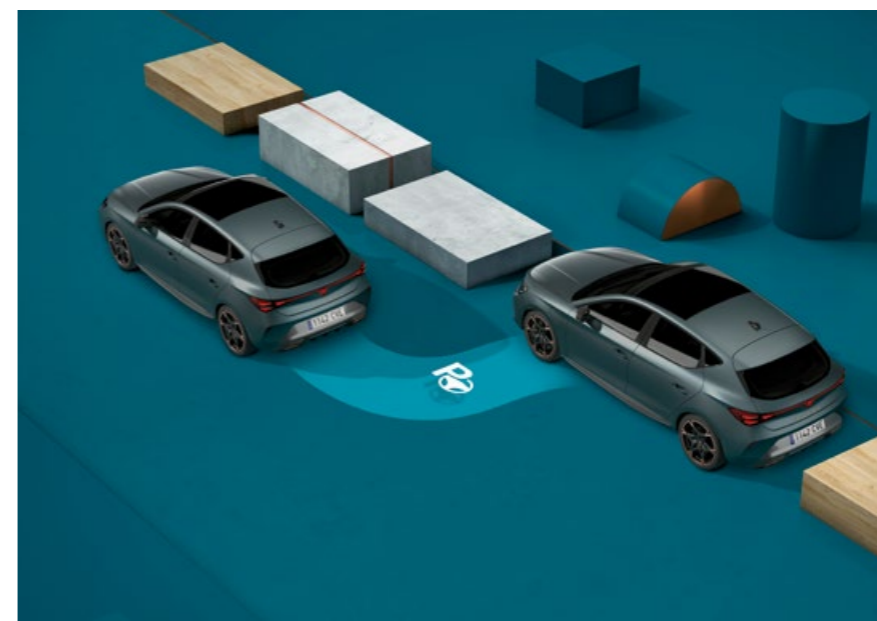

SATELITES WHEEL ASSERTION

Command your CUPRA LEON with the CUPRA Steering Wheel with Satellites, blending relaxation with the thrill of choice between manual flair and automatic ease. Our satellite buttons allow you to access a full range of driving functions without lifting a hand from the wheel.



INNOVATION

Our global range of cars and product specifications varies from country to country. Please, visit your local CUPRA website to know more about the product offer available for you.



SAFETY



PREDICTIVE ACC

Advanced Predictive ACC in the CUPRA Leon forecasts the road ahead, adapting speed intuitively for curves, signs, and intersections. This provides you with a smooth and comfortable ride, making every journey safer and more enjoyable.



SIDE ASSIST & EXIT ASSIST

Rely on the vigilant Side Assist & Exit Warning for a safer lane transition and secure exits amid busy surrounds. A security layer like this adds an extra layer of peace of mind to your drive.



PRECRASH

In the CUPRA Leon, the Pre-crash system proactively protects you by tightening seat belts and closing windows after anticipating potential hazards.

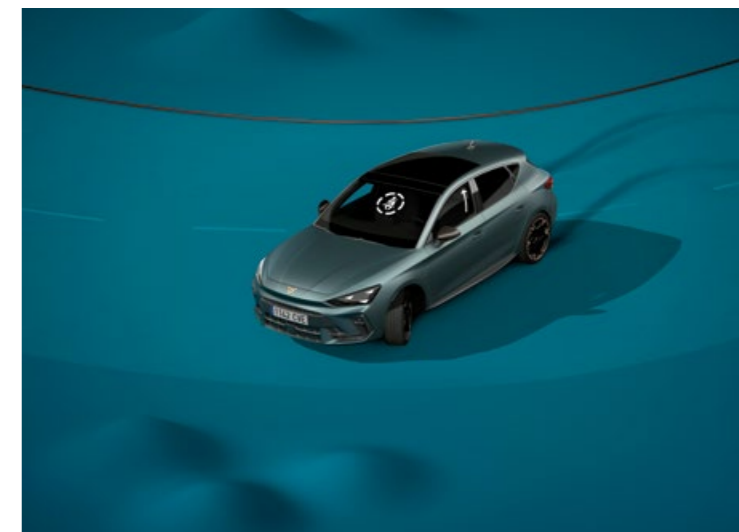

TRAFFIC SIGN RECOGNITION

With the Traffic Sign Recognition, the CUPRA Leon enhances your driving intelligence, interpreting and projecting essential traffic information directly onto your dashboard and sending notifications for speed limits.

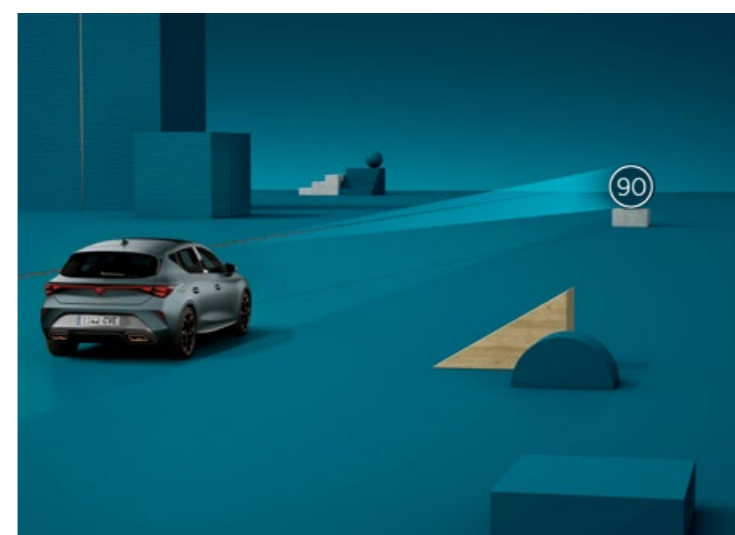

LIGHT ASSIST

Light Assist in the CUPRA Leon makes your nighttime drive less daunting and more delightful. As if you had a vigilant co-pilot, your path is illuminated. The system automatically adjusts the headlight beams to provide optimal visibility, ensuring a clear view of the road ahead.

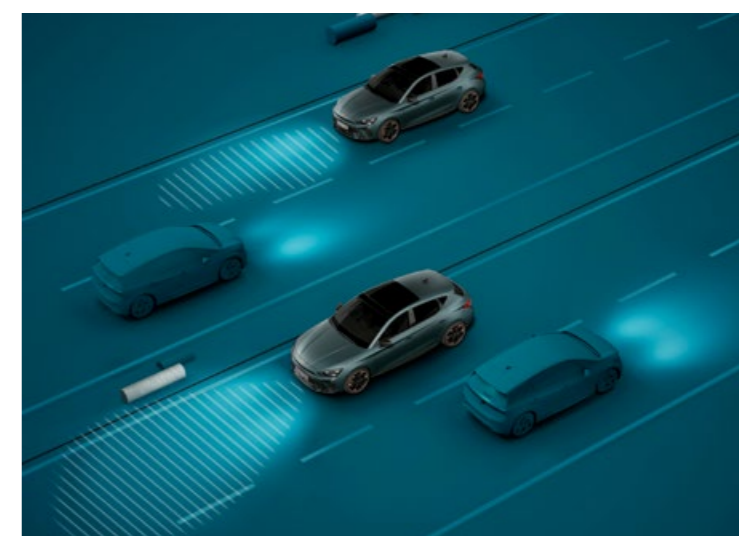



UPGRADES

EDGE

The EDGE suite in the CUPRA Leon epitomizes modern driving elegance. Keyless advanced and an alarm system offer seamless access and security, while ambient lighting and comprehensive rear vision enhance your driving environment. Adding to the suite's convenience, the SPORTSTOURER features the Virtual Pedal, allowing you to open the boot hands-free without reaching for your keys.



INNOVATION

Our global range of cars and product specifications varies from country to country. Please, visit your local CUPRA website to know more about the product offer available for you.



IMMERSIVE BY SENNHEISER™

Experience auditory bliss with Immersive by Sennheiser™, exclusive to the CUPRA Leon. This premium sound system envelops you in a rich tapestry of sound with its 11 speakers and a powerful subwoofer, creating a concert hall on wheels where every note and beat is a celebration of pure sound.



SKYLINE

The Skyline feature invites the outside in, with a panoramic sunroof that bathes the interior in natural light. At the touch of a button, it opens up to reveal the sky, transforming your cabin into a tranquil sanctuary where light and space converge.





INTELLIGENT DRIVE

CUPRA Leon stands at the pinnacle of automotive intelligence, featuring the most disruptive assistance systems, including Intelligent Park Assist, Navigation, and Pre-Crash technology. This suite of advanced safety tech, is powered by a multifunction camera, Adaptive Cruise Control, Lane Keeping, and a live dynamic road sign display.



EXTREME

Enjoy the thrill of the EXTREME upgrade with performance brakes plus the CUPRA Matrix LED headlights.

This upgrade also features an exclusive interior design with dark chrome details, and CUP bucket seats. This is complemented by a dedicated interior in Enceladus Grey Matt. CUPRA's commitment to excellence is embodied in this meticulous combination of style and performance elements, including a side skirt and roof spoiler that enhances the vehicle's aesthetics and driving dynamics.



THE DARK PACK

CUPRA Leon's Dark Pack adds substance to a great vehicle. With dark aluminium side skirts for a refined sporty finish, a dark glossy black roof spoiler for added class, and the bold Dark Shadow alloy wheels, this pack makes every journey special.



PURE PERFORMANCE

Experience the radiant beauty of Pure Performance, where the CUPRA Matrix LED technology guides you with clarity and style.



Our global range of cars and product specifications varies from country to country. Please, visit your local CUPRA website to know more about the product offer available for you.



LEISURE

In the CUPRA Leon, leisure is redefined as an exquisite journey, elevating beyond mere relaxation to an art form where every moment is an exploration of pure joy. This is a space where passion fuels every journey, transforming routine trips into thrilling escapades.

Join us in this pursuit, where every drive invites you to immerse yourself in the moment, leaving lasting memories on the open road.



ACCESSORIES



SNOW & WINTER READY: SKI RACK XTENDER

A Sliding mechanism makes loading quicker, easier and safer. It can carry 5 pairs of skis or 2 snowboards. Soft rubber pads protect the skis during transport.



STREAMLINED STORAGE: ROOF BOX

Optimize your cargo capacity with the sleek, aerodynamic roof box—ideal for extended road trips and carrying extra gear.



ELEVATED ELEGANCE: ROOF BARS

The CUPRA Leon's roof bars blend functionality with finesse, providing a robust platform for adventure while accentuating its sleek silhouette.



DEFINED TRANSPORT: TOWING BIKE RACK

Designed to securely carry up to two bikes, this rack can handle a total weight of up to 60 kg.



Our global range of cars and product specifications varies from country to country. Please, visit your local CUPRA website to know more about the product offer available for you.



CUPRA CARE: INTEGRATED COVERAGE FOR YOUR WELL-BEING

Taking care for your CUPRA to the next level with a plan designed to suit a car as unique as yours. It offers cost advantage since different products are combined in a single package and exclusive services developed specifically for the CUPRA Customer.

WARRANTY EXTENSION

Extend your 2-year CUPRA manufacturer's warranty for an additional 1, 2, or 3 years, or up to 150,000 km, whichever comes first. For newly purchased cars, this extended warranty is already included, ensuring your satisfaction from the start.

SERVICE AND MAINTENANCE PACKAGES

Cover all essential maintenance and routine inspections recommended by the manufacturer with this plan. Common services include oil changes and the timely replacement of filters, depending on your CUPRA Leon's age and mileage.



CUPRA MOBILITY SERVICES

Whether your car needs a tow or its battery runs out, rely on our enduring 24/7 roadside assistance, valid for 10 years. Available throughout the EU and neighboring nations, with the added bonus of 2 free years upon your CUPRA purchase.

RELAX INTO THE IMPULSE

CUPRA Insurance, custom-designed for your vehicle, ensures year-round protection. With 24-hour support and repairs in official workshops using genuine parts, you're quickly back on track. Plus, in case of vandalism or theft, a courtesy car is guaranteed.

Our global range of cars and product specifications varies from country to country. Please, visit your local CUPRA website to know more about the product offer available for you.



ENVIRONMENTAL INFORMATION

LIGHTING

Headlamps and rear lamps are 100% LED, increasing life service by up to 10 times. For headlamps, power consumption is significantly reduced at least 30%, and the luminous flux effectiveness is increased at least 30% in comparison to a halogen lamp.

RECYCLED MATERIALS

Seat bucket (no leather) configuration: In its central area contains microfiber Dinamica® with 73% of recycled polyester (pre-consumer and post-consumer origin).

Seat cupbucket configuration: In its central area contains microfiber Dinamica® with 73% of recycled polyester (pre-consumer and post-consumer origin).

ENGINES

Diesel: 2.0l Diesel engines allow the use of R100 fuel. R100 is made from 100% renewable raw material (Hydrotreated Vegetable Oil, HVO), achieving a reduction of up to 90% in CO₂ emissions during its production, compared to a conventional fuel.

e-HYBRID: The all-electric motor in the e-HYBRID engine enables zero tailpipe emission driving in electric mode.

MANUFACTURING PROCESS

Between 2010 and 2023, we reduced the CO₂ emissions per manufactured car by 69.3%, while also cutting the energy demand per car by 33.3%. Additionally, we achieved a 45.1% saving in water consumption and a 78.9% reduction in waste generated per car.

In our path towards a circular economy, we have established a process for dismantling discarded parts and components. This process breaks down complex items into single-material parts, enabling proper segregation and giving these materials a second life. As a result, what was once considered non-recoverable waste is now transformed into revalorized, reusable materials.

ZERO EMISSION (E-HYBRID)

An indicator that displays the distance driven with zero tailpipe emissions in e-mode.

E-RANGE MONITOR (E-HYBRID)

Informs the driver of the increase in range of electric-only engine when combustion -only is off.



SEAT S.A.'s environmental mission. Protect Climate. Conserve Resources. Preserve Ecosystems. Ensure Environmental Compliance.

Our global range of cars and product specifications varies from country to country. Please, visit your local CUPRA website to know more about the product offer available for you.



TECHNICALS

In the realm of CUPRA Leon, technical prowess is more than mere numbers; it's a symphony of engineering achievements. Here, every detail sings of dedication to excellence, marrying power with sustainability, efficiency with passion. This is where state-of-the-art transmission systems and optimized fuel consumption converge, creating a driving experience that connects you with the heart of the road.



STANDARD & OPTIONAL EQUIPMENT CUPRA LEON AND SPORTSTOURER

- ▼ Standard
- ▽ Optional
- Not available

SAFETY

	CUPRA LEON	CUPRA LEON VZ
Airbag for driver and front passenger with front passenger airbag deactivation	▼	▼
Side airbag in front with curtain airbag, interaction airbag in front and center airbag.	▼	▼
Rear side airbag + Knee airbag ¹	▽	▽
3-point seat belt for center rear seat	▼	▼
3-point seat belts, front ²	▼	▼
3-point seat belts in front with pretensioner, without height adjustment ³	▼	▼
3-point seat belts, outer rear with ECE label	▼	▼
i-Size and Top Tether child seat anchors in front passenger side	▼	▼
eCall (Public emergency call)	▼	▼

¹ Not compatible with EXTREME pack.
² Not available for e-Hybrid engines.
³ Only for e-Hybrid engines.

Our global range of cars and product specifications varies from country to country. Please, visit your local CUPRA website to know more about the product offer available for you.

EQUIPMENT

- ▼ Standard
- ▽ Optional
- Not available

SAFETY

	CUPRA LEON	CUPRA LEON VZ
Safe & NCAP pack:		
- Forward collision warning with warning and braking reaction to vehicles, pedestrians and cyclists	▼	▼
- Speed limiter with anticipated regulation		
- Dynamic road sign display		
- With multifunction camera		
- Lane keeping system		
- With emergency steering support with turn assist		
- Attention and drowsiness Assist		
Safe & Driving Pack M⁵:		
- Adaptive Cruise Control		
- Speed limiter with anticipated regulation	▼	▼
- Attention and drowsiness assist		
- High-beam control		
- Light assist		
- Traffic sign recognition		
- CUPRA steering wheel with triptronic, heated, with satellites buttons		

⁴ Requires CUPRA Connect plus or CUPRA Connect plus 5 years (optional with Navy) if online service + Navigation system without media Internet package for countries with cartography. For VZ engines, Keyless Go will be Keyless Advanced.
⁵ ACC is predictive when combined with traffic sign recognition.



2024

- ▼ Standard
- ▽ Optional
- Not available

EQUIPMENT

EXTERIOR

	CUPRA LEON	CUPRA LEON VZ
Towing hook preinstallation ⁶	▽	▽
Electric towing hook ⁷	▽	▽
Mirror covers in carbon fiber black ⁸	▽	▽
Mirror covers in carbon fiber copper ⁹	▽	▽
CUPRA Side Skirts ¹⁰	▽	▽
CUPRA Side Skirts + Black Roof Spoiler ¹¹	▽	▽
Heat-insulating and tinted rear windows	▼	▼
Front and rear power windows	▼	▼
Glossy black frame windows	▼	▼
Heat insulating windshield (Acoustic reduction windshield)	▼	▼
CUPRA lettering and VZ logo in Dark Chrome ¹²	-	▼
CUPRA lettering in Copper ¹³	▼	▼
Exterior mirrors, power-folding, adjustable and heated with front passenger exterior mirror lowering function	▼	-
Exterior mirrors, power-folding, adjustable and independently heated with front passenger exterior mirror lowering function	-	▼
Front LED with signature: Biled LED-Full LED		
- LED headlamps	▼	▼
- Full LED rear lights without dynamic light	▼	▼
- Welcome light in exterior mirrors		
- Front fog lamps		
- Daytime running lights		

⁶ Not compatible with Electric towing hook. Not compatible with SKYLINE - Panorama Electric Sunroof, when e-Hybrid engines for Sportstourer. Not available for 5D PHEV.

⁷ Not compatible with Towing hook preinstallation. Not compatible with SKYLINE - Panorama Electric Sunroof, when e-Hybrid engines for Sportstourer. Not available for 5D PHEV.

⁸ Not compatible with mirror covers in carbon fiber copper.

⁹ Not compatible with mirror covers in carbon fiber black.

¹⁰ Not compatible with CUPRA Side Skirts + Black Roof Spoiler.

¹¹ Not compatible with CUPRA Side Skirts.

¹² Only for 2.0 TSI 245 kW (333 hp) & 2.0 TSI evo 221 kW (300 hp) engines.

¹³ Not available for 2.0 TSI 245 kW (333 hp) & 2.0 TSI evo 221 kW (300 hp) engines.

Our global range of cars and product specifications varies from country to country. Please, visit your local CUPRA website to know more about the product offer available for you.

- ▼ Standard
- ▽ Optional
- Not available

EQUIPMENT

EXTERIOR

	CUPRA LEON	CUPRA LEON VZ
18" GARBI ¹⁴	▼	-
18" GARBI COPPER ¹⁴	▽	-
18" WINDSTORM ¹⁴	▽	-
19" POLAR ¹⁵	-	▼
DRIVING PERFORMANCE - 19" POLAR wheel - Drive Profile (DCC - Dynamic Chassis Control) ¹⁶	▽	-
19" POLAR COPPER	-	▽
DRIVING PERFORMANCE - 19" POLAR COPPER wheel - Drive Profile (DCC - Dynamic Chassis Control) ¹⁶	▽	-
19" MISTRAL	-	▽
DRIVING PERFORMANCE - 19" MISTRAL wheel - Drive Profile (DCC - Dynamic Chassis Control) ¹⁶	▽	-
19" MISTRAL COPPER	-	▽
DRIVING PERFORMANCE - 19" MISTRAL COPPER wheel - Drive Profile (DCC - Dynamic Chassis Control)	▽	-
19" HAILSTORM	-	▽
19" HAILSTORM COPPER	-	▽
19" HAILSTORM COPPER WITH AKEBONO BRAKES ¹⁷	-	▽
Emergency spare wheel 18" ¹⁸	▽	-
Performance Tyre ¹⁹	-	▽
All season tyres ²⁰	▽	-
Brembo brakes ²¹	-	▽

¹⁴ Not compatible with Performance Tyre.

¹⁵ Requires EDGE Pack.

¹⁶ Requires Edge Pack for Leon Engines. Not compatible with 2.0 TDI evo 110 kW.

¹⁷ Only available for 2.0 TSI evo 221 kW and 245 kW engines.

¹⁸ Not available for Brembo Brakes & Akebono Brakes. Not available for e-Hybrid engines.

¹⁹ Not compatible with POLAR 19" wheel. Not compatible with e-Hybrid engine.

²⁰ Only available with 18" wheel.

²¹ Only available for 200kW PHEV. Not compatible with Emergency spare wheel 18".



2024

EQUIPMENT

- ▼ Standard
- ▽ Optional
- Not available

INTERIOR

	CUPRA LEON	CUPRA LEON VZ
Interior roof in black (black Greenhouse)	▼	▼
Leather Gearshift knob/handle in vegan leather ²²	▼	-
Leather-wrapped multi-function steering wheel ²²	▼	-
CUPRA Leather-wrapped multi-function steering wheel, with tiptronic, satellites and Electronic cruise control system ²³	▼	▼
Metallic pedal cluster ²³	▼	▼
Dark alu glossy package - Chrome package	▼	▼
Illuminated CUPRA lettering in door aperture	▼	▼
Two reading lights in front, two in rear + light in boot in LED	▼	▼
Separate daytime running light with automatic headlight control and Coming Home feature (automatic)	▼	▼
Climatronic (3-zone) with air conditioning control panel in rear:	▼	▼
- Air Quality Sensor - AirCare		
Rear view mirror, auto-dimming	▼	▼
Windshield wiper intermittent control with light/rain sensor	▼	▼

²² Only for 1.5 TSI 110 kW (150 hp) engine.

²³ Not available for CUPRA Leon 5D & Sportstourer 1.5 TSI 110 kW MQ engine.

Our global range of cars and product specifications varies from country to country. Please, visit your local CUPRA website to know more about the product offer available for you.

EQUIPMENT

- ▼ Standard
- ▽ Optional
- Not available

INTERIOR

	CUPRA LEON	CUPRA LEON VZ
Sharp Ambient*²⁴:		
- Sport seats		
- Textile upholstery		
- Manual height adjustment for front seats	▼	-
- Manual-adjustable lumbar support for left and right front seat		
- Drawer under right front seat		
- Child seat anchors for child seat system i-Size, with top tether and child seat anchors in front-on-front passenger side		
DYNAMIC DESIGN - Dinamica Ambient²⁵:		
- Bucket seats in Dinamica upholstery.		
- Left seat: Power seat adjustment with memory feature and power-adjustable lumbar support	▽	▼
- Right seat: manually height-adjustable		
- Separately controlled heated front seats		
- Door panels		
- Exterior mirrors with memory feature, power-folding, separately heated		
PROGRESSIVE DESIGN - Metallized Ambient²⁵:		
- Bucket seats with conscious leather upholstery		
- Power seat adjustment with memory feature and power-adjustable lumbar support for front seats	▽	▽
- Separately controlled heated front seats.		
- Door panels		
- Exterior mirrors with memory feature, power-folding, separately heated		

²⁴ Without drawer for mHEV.

²⁵ Requires: Edge Pack for Leon Engines. Not compatible with Winter pack.

* Not compatible with Century Bronze Matt and Enceladus Grey Matt.



2024

- ▼ Standard
- ▽ Optional
- Not available

EQUIPMENT

TECHNOLOGY

	CUPRA LEON	CUPRA LEON VZ
CUPRA Connect:		
- Online service, with OCU and head unit coding	▽	▽
CUPRA Connect plus 3 years (standard with Navi) ²⁶	▽	▽
CUPRA Connect plus 5 years ²⁷	▽	▽
DAB (Digital Audio Broadcasting)	▽	▽
Charging Cable Mode 2 / type E+F (10 A) ²⁸	▼	▼
MODE 3 Cable for e-HYBRID:		
16 A or 32 A	▽	▽
CUPRA Charger Connect 2 11 kW	▽	▽
CUPRA Charger Connect 2 22 kW	▽	▽
CUPRA Charger Pro 2	▽	▽
Digital Cockpit 10,25"	▼	▼
Park distance control (front & rear parking sensor)	▼	▼
Servotronic with limited steering lift mechanism	-	▼
Dynamic Steering ²⁹	▼	-
Driving profile selection and conventional shock absorber	▼	-

²⁶ Not compatible with CUPRA Connect plus 5 years.²⁷ Service extension from 3 to 5 years for navigation.²⁸ Not compatible with CUPRA Connect plus 3 years.²⁹ Only available in e-Hybrid engines.²⁹ Except 150 kW e-Hybrid and 2.0 TSI 150 kW 4Drive, equipped with Servotronic.

Our global range of cars and product specifications varies from country to country. Please, visit your local CUPRA website to know more about the product offer available for you.

- ▼ Standard
- ▽ Optional
- Not available

EQUIPMENT

TECHNOLOGY

	CUPRA LEON	CUPRA LEON VZ
Driver Profile Selection and Dynamic Chassis Control (DCC)	-	▼
Electronic cruise control system (CCS)	▼	▼
Rear view camera system	-	▼
Infotainment system 12,9"	▼	▼
Ready for Navi	▼	▼
Full Link wireless&wired, with WLAN	▼	▼
7 speakers	▼	▼
Connectivity box with Koppelantenne:		
- Bluetooth	▼	▼
- Mobile Phone Interface		
Two illuminated external USB type C data & load socket front and load at rear	▼	▼
230-V inverter and outlet ³⁰	▼	▼
Voice control	▼	▼
Keyless Go	▼	-
Winter Pack³¹:		
Heated front seats Separately controlled	▽	▼
Keyless Advanced	-	▼
Virtual Pedal ³²	-	▼

³⁰ Not available in MHEV and TDI engines until July 2024.³¹ Not compatible with Dynamic Design & Progressive Design.³² Only available Sportstourer.



2024

EQUIPMENT

- ▼ Standard
- ▽ Optional
- Not available

UPGRADES

	CUPRA LEON	CUPRA LEON VZ
EDGE³³:		
- Keyless locking and starting system Keyless Advanced	▽	▼
- Anti-theft alarm system, interior monitoring, backup horn and towing protection		
- Interior ambient lighting wrap around		
- With Rear View Camera system		
- Virtual Pedal		
EXTREME for 200 kW PHEV		
CUP Bucket seats (includes Winter Pack)³⁴:		
- Power seat adjustment with memory feature and power-adjustable lumbar support for front seats		
- Side airbag in front and rear with curtain airbag		
- Airbag for driver and front passenger with knee airbag and front passenger airbag deactivation		
CUPR Matrix LED with signature and ceremony		
With multifunction camera		
Safe & Driving Pack XL in combination with Navi System +		
- Traffic sign recognition		
- Steering Wheel with triptronic, heated, with satellites		
- Adaptive cruise control (with "follow-to-stop")		
- Attention and drowsiness Assist.	-	▽
- Side assist & Exit Assist & Exit Warning		
- Lane keeping system plus semi-automatic vehicle control in a medical emergency and traffic jam assist		
Preocrash Front & Rear		
Speed limiter with anticipated regulation		
Intelligent Park Assist*		
Navigation system without media Internet package for countries with cartography		
IMMERSIVE Sennheiser™		
11 speakers + 1 subwoofer		
Brembo Brakes		
Disc brakes + Brembo callipers in Front		
Side Skirts		
Black roof spoiler		

³³ Virtual pedal only available for Leon Sportstourer.

³⁴ Includes: PURE PERFORMANCE, INTELLIGENT DRIVE & INMERSIVE BY SENNHEISER upgrades.
In the exterior includes side skirts, black roof spoiler, and for the interior: air vent frames, steering wheel details & central console in dark chrome. Available with wheels: 19" POLAR COPPER, 19" MISTRAL, 19" MISTRAL COPPER, 19" HAILSTROM or 19"HAILSTROM COPPER. Not compatible with Emergency wheel 18". Requires CUPRA Connect plus or CUPRA Connect plus 5 years (optional with Navy) if online service + Navigation system without media Internet package for countries with cartography.
Not compatible with PROGRESSIVE DESIGN, Winter pack, Rear side airbag + Knee airbag + central airbag, Safe & Driving Pack M, IMMERSIVE BY Sennheiser (for Dinamica Ambient and Metallized Ambient), INTELLIGENT DRIVE DQ, PURE PERFORMANCE upgrade by itself, Brembo & Akebob Performance brakes & CUPRA Side Skirts.

Our global range of cars and product specifications varies from country to country. Please, visit your local CUPRA website to know more about the product offer available for you.

EQUIPMENT

- ▼ Standard
- ▽ Optional
- Not available

UPGRADES

	CUPRA LEON	CUPRA LEON VZ
EXTREME		
CUP Bucket seats (includes Winter Pack)³⁴:		
- Power seat adjustment with memory feature and power-adjustable lumbar support for front seats		
- Side airbag in front and rear with curtain airbag		
- Airbag for driver and front passenger with knee airbag and front passenger airbag deactivation		
CUPRA Matrix LED with signature with ceremony		
With multifunction camera		
Safe & Driving Pack XL in combination with Navi System +		
- Traffic Sign recognition		
- Steering Wheel with triptronic, heated, with satellites		
- Adaptive cruise control (with "follow-to-stop")		
- Attention and drowsiness Assist	-	▽
- Side assist & Exit Assist & Exit Warning		
- Lane keeping system plus semi-automatic vehicle control in a medical emergency and traffic jam assist		
Preocrash Front & Rear		
Speed limiter with anticipated regulation		
Intelligent Park Assist + Rear Park Assist		
Navigation system without media Internet package for countries with cartography		
IMMERSIVE Sennheiser™		
11 speakers + 1 subwoofer		
19" HAILSTORM COPPER with Akebono Brakes		
Disc brakes + Akebono caliper in Front		
Side Skirts		
Black roof spoiler		
SKYLINE (Panorama Electric Sunroof)³⁵	▽	▽
IMMERSIVE BY Sennheiser™ - Sharp Ambient Amplif. 11 speakers + 1 subwoofer³⁶:	▽	-
- Door and side trim panel		

³⁵ Requires: Edge Pack for Leon Engines.

³⁶ Requires: Edge Pack & Emergency spare wheel 18" except if e-Hybrid engine.



2024

EQUIPMENT

- ▼ Standard
- ▽ Optional
- Not available

UPGRADES

	CUPRA LEON	CUPRA LEON VZ
IMMERSIVE BY Sennheiser™ - Dinamica Ambient, Metallized Ambient³⁷:	▽	▽
Amplif. 11 speakers + 1 subwoofer		
INTELLIGENT DRIVE for MQ engines		
Safe & Driving Pack L in combination with Navi System +³⁸:		
- With dynamic road sign display		
- Adaptive cruise control (with "follow-to-stop")		
- Attention and drowsiness Assist		
- Side assist (lane change assist) / Exit Assist (parking exist assist) / Exit	▽	
- Warning (vehicle exit warning)		
- High-beam control		
- With multifunction camera		
Precrash Front & Rear		
Speed limiter with anticipated regulation		
Navigation system without media Internet package for countries with cartography		

³⁷ Requires: Only for Leon engines Edge Pack & Emergency spare wheel 18" except if e-Hybrid engine. Not compatible with EXTREME pack.

³⁸ Requires: Edge Pack for Leon Engines. Requires CUPRA Connect plus 3 years or CUPRA Connect plus 5 years. if EL5 + 7UY. Not compatible with Safe & Driving Pack M as an option. ACC is predictive when combined with Traffic sign recognition.

Our global range of cars and product specifications varies from country to country. Please, visit your local CUPRA website to know more about the product offer available for you.

EQUIPMENT

- ▼ Standard
- ▽ Optional
- Not available

UPGRADES

	CUPRA LEON	CUPRA LEON VZ
INTELLIGENT DRIVE DQ		
Safe & Driving Pack XL in combination with Navi System +³⁹:		
- With dynamic road sign display		
- Steering Wheel with triptronic and satellites, heated.		
- Adaptive cruise control (with "follow-to-stop")		
- Attention and drowsiness Assist		
- Side assist (lane change assist) / Exit Assist (parking exist assist) / Exit -		
- Warning (vehicle exit warning)	▽	▽
- With multifunction camera		
- Lane keeping system plus semi-automatic vehicle control in a medical emergency and traffic jam assist		
- High-beam control		
Precrash Front & Rear		
Speed limiter with anticipated regulation		
Intelligent Park Assist		
Navigation system without media Internet package for countries with cartography		
PURE PERFORMANCE⁴⁰:		
- CUPRA Matrix LED with signature ceremony	▽	▽
- LED headlamps with variable light distribution		
- Matrix beam		
- With multifunction camera		
DARK PACK:		
Alloy wheels 7.5Jx18 in Dark Shadow	▽	-
- Wheel bolts with anti-theft protection (unlockable)		
Side Skirts		
Black roof spoiler		

³⁹ Requires: Edge Pack for Leon Engines. Requires CUPRA Connect plus 3 years or CUPRA Connect plus 5 years) if online service + Navigation system without media Internet package for countries with cartography. Not compatible with Safe & Driving Pack M as an option. ACC is predictive when combined with Traffic sign recognition.

⁴⁰ Requires: Edge Pack for Leon Engines.



ACCESSORIES

INTERIOR

	REFERENCE
Dark aluminium pedals (manual)	5FA064200 9DG
Dark aluminium pedals	5FA071750 9DG
Dark aluminium pedals (automatic)	5FA064205 9DG

ACCESSORIES

SAFETY

	REFERENCE
Automatic anti-puncture kit	000093059AE
Snow chains (Autosock) - 245/40 R19	000091375EH
20,000 mAh battery jump starter + charger	000051763H
Help flash	000052122A
Warning triangle (2 units)	000093601A
Base for i-SENSE baby car seat	000019230M
Reflective vest	000093900SA
KIDFIX i-Size (100-150 cm)	000019906AK
KIDFIX i-Size (76-105cm, 9-22kg)	000019909H
Baby-Safe 3 i-SIZE (0-83 cm)	000019907C
CUPRA safety kit (1 mini triangle + vest + large first-aid kit)	6H3093990AC
CUPRA safety kit (emergency light + vest + large first-aid kit)	6H3093990AB



TRANSPORT

	REFERENCE
Electric kit for vehicles without preinstallation	5FA055204
Tow bar (not valid for PHEV vehicles)	5FA092160D
Towing Bike Rack	000071128K
Roof Bars	5FE071151
Bike Rack	5F9071128
Ski Rack for 6 pairs or 4 snowboards	000071129T
Ski Rack for 4 pairs or 2 snowboards	000071129S
Ski Rack Xtender	000071129R
CUPRA car cover	6H3061701A

ACCESSORIES

PROTECTION

	REFERENCE
Floor mats - Dynamic (LHD)	5FG863011S LOE
Floor mats - Dynamic (RHD)	5FH863011P LOE
Floor mats MHEV - Dynamic (LHD)	5FG863011ADLOE
Floor mats MHEV - Dynamic (RHD)	5FH863011AALOE
Semirigid boot tray only for CUPRA Leon 5D	5FA061201F
Floor mats - Extreme Pack (LHD)	5FG863011AA LOE
Floor mats - Extreme Pack (RHD)	5FH863011R LOE
Floor mats MHEV - Extreme Pack (LHD)	5FG863011AF LOE
Floor mats MHEV - Extreme Pack (RHD)	5FH863011AC LOE
Floor mats - Progressive Design (RHD)	5FH863011Q LOE
Floor mats - Progressive Design (LHD)	5FG863011T LOE
Floor mats MHEV - Progressive Design (LHD)	5FG863011AE LOE
Floor mats MHEV - Progressive Design (RHD)	5FH863011AB LOE
Floor mats TPE (LHD)	5FG061500 041
Separation grille	5FE017221
Reversible boot matt	5FE061201A
Front mudflaps	5FF075111B



ENGINE SPECS CUPRA LEON AND SPORTSTOURER

PETROL ENGINE

1.5 eTSI 150 HP (110 KW) MHEV DSG-7 START/STOP
CUPRA LEON | CUPRA LEON SPORTSTOURER

Cylinder/Valve (Total)	4 / 16
Displacement (cc)	1.498
Cylinder bore and stroke (mm)	74,5 / 85,9
Compression ratio	12,0
Maximum power (kW (PS)/rpm)	110 (150) / 5000 - 6000
Maximum torque (Nm/rpm)	250/ 1500- 3500
Fuel supply system	TSI Direct Injection
Ignition	Electronic map-controlled ignition
Atmospheric/Supercharged	Turbo charged
Fuel type	ROZ 95
Oil capacity in initial fill (l)	4.8
Alternator (A)	-
Battery (Ah/A)	59-70-68 / 380-420-380

ENGINE SPECS

PERFORMANCE

1.5 eTSI 150 HP (110 KW) MHEV DSG-7 START/STOP
CUPRA LEON | CUPRA LEON SPORTSTOURER

Maximum speed [km/h (gear)]	215 216 (V)
Acceleration 0-100 km/h (s)	8.7 9.0

FUEL CONSUMPTION

Combined WLTP (l/100)	5.6 - 5.9 5.6 - 6.0
-----------------------	-----------------------

MASS EMISSION

CO ₂ Combined WLTP (g/km)	124 - 134 125 - 136
--------------------------------------	-----------------------

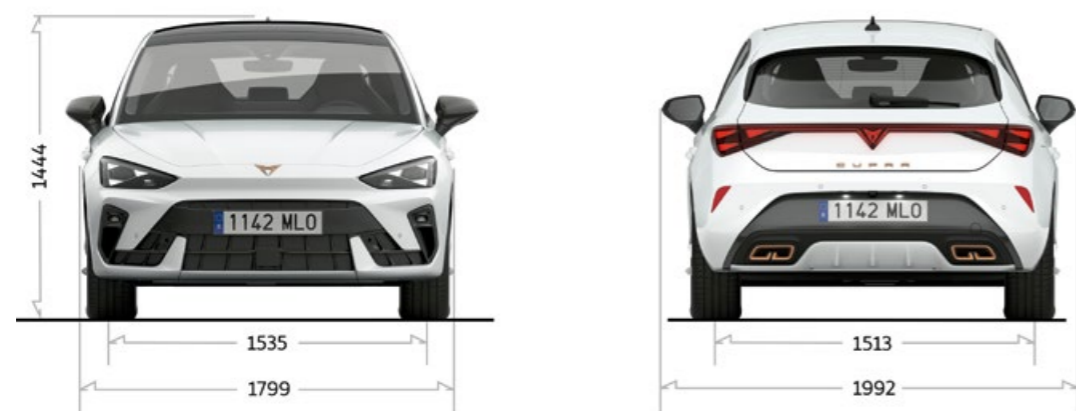

ENGINE SPECS

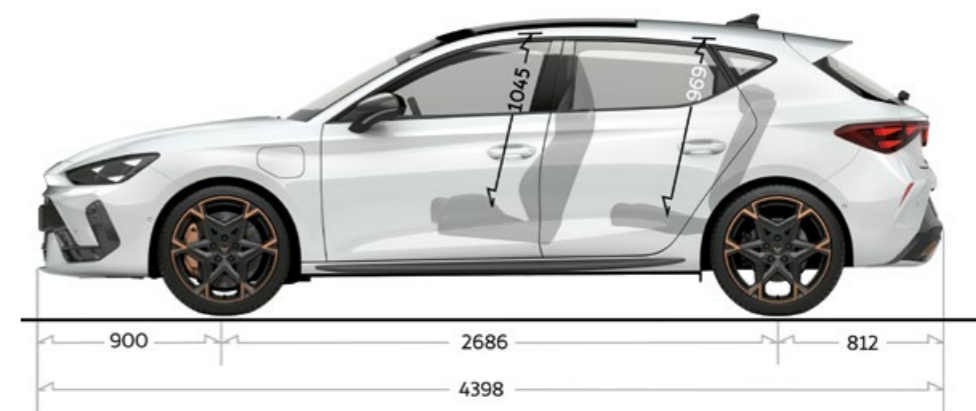

CHASSIS

1.5 eTSI 150 HP (110 KW) MHEV DSG-7 START/STOP
CUPRA LEON | CUPRA LEON SPORTSTOURER

Front suspension	Independent type McPherson - coil springs - hydraulic shock absorber DCC equipment (Adaptive chassis control)
Rear suspension	Semirigid axle, Multilink axle (with 19" Rims), coil springs and hydraulic shock absorber - DCC equipment (Adaptive chassis control)

STEERING

Steering system	R-EPS (Rack Electric Power System); Progressive steering
Turning Circle Diameter (m)	10.8

BRAKES

Brake system	Dual hydraulic circuit and brake system diagonal split with electric brake booster
Front and rear brake type	Front ventilated disc brakes and rear solid disc brakes
Front brakes (mm)	288×25 (306×26 with DCC)
Rear brakes (mm)	272×10

WHEELS

1.5 eTSI 150 HP (110 KW) MHEV DSG-7 START/STOP
CUPRA LEON | CUPRA LEON SPORTSTOURER

Rims	7,5J×18 ET46; 8J×19 ET49
Tyres	225/40 R18; 235/35 R19



PACKAGE (IN RUNNING WITHOUT DRIVER)

1.5 eTSI 150 HP (110 KW) MHEV DSG-7 START/STOP
CUPRA LEON | CUPRA LEON SPORTSTOURER

Body Type	CUPRA Leon CUPRA Leon Sportstourer
Length/width/height (mm)	4,398 / 1,799 / 1,444 4,657 / 1,799 / 1,438
Wheelbase (mm)	2686 (VL) - 2683 (ML)
Front/Rear track (mm)	1545 / 1514 1545 / 1514
Boot capacity (l)	380 620
Fuel tank capacity (l)	45 (VL) / 50 (ML)

ENGINE SPECS

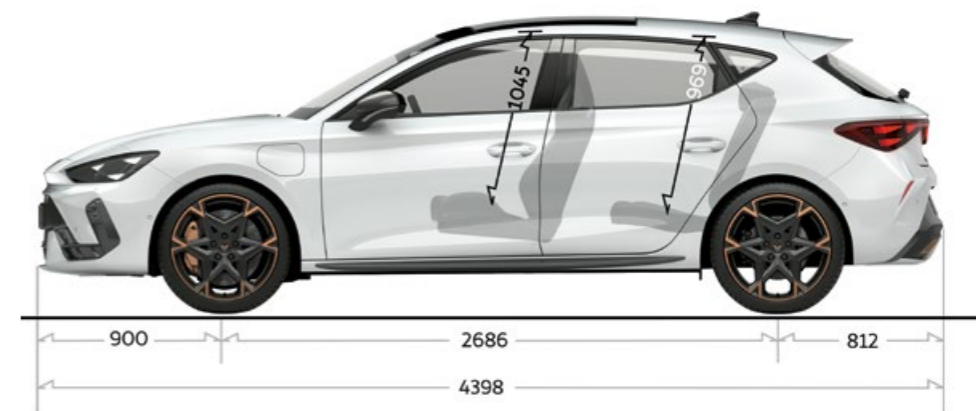

WEIGHTS

1.5 eTSI 150 HP (110 KW) MHEV DSG-7 START/STOP
CUPRA LEON | CUPRA LEON SPORTSTOURER

In running order with driver (kg)	1.401 - 1.441 1447 - 1486
In running order with driver (kg) Front/Rear	857 / 544 - 869 / 572 841 / 606 - 853 / 633
Maximum weight allowed (kg)	1.890 - 1.910 1.970 / 2.000
Max. towing weight without brake (kg) (*)	700 - 720 720 / 740
Max. towing weight with brake 8% (kg)	1,700
Max. Towing weight with brake 12% (kg)	1,500



ENGINE SPECS CUPRA LEON AND SPORTSTOURER

ENGINE SPECS

PETROL ENGINE

1.5 TSI 150 HP (110 KW) 6-SPEED MANUAL START/STOP
CUPRA LEON | CUPRA LEON SPORTSTOURER

Cylinder/Valve (Total)	4 / 16
Displacement (cc)	1.498
Cylinder bore and stroke (mm)	74,5 / 85,9
Compression ratio	12,0
Maximum power (kW (PS)/rpm)	110 (150) / 5000 - 6000
Maximum torque (Nm/rpm)	250/ 1500- 3500
Fuel supply system	TSI Direct Injection
Ignition	Electronic map-controlled ignition
Atmospheric/Supercharged	Turbo charged
Fuel type	ROZ 95
Oil capacity in initial fill (l)	4.8
Alternator (A)	140A (8GU)
Battery (Ah/A)	59-70-68 / 380-420-380

PERFORMANCE

1.5 TSI 150 HP (110 KW) 6-SPEED MANUAL START/STOP
CUPRA LEON | CUPRA LEON SPORTSTOURER

Maximum speed [km/h (gear)]	215 216 (V)
Acceleration 0-100 km/h (s)	8.9 9.2

FUEL CONSUMPTION

Combined WLTP (l/100)	5.7 - 6.2 5.8 - 6.3
-----------------------	-----------------------

MASS EMISSION

CO ₂ Combined WLTP (g/km)	131 - 141 132 - 143
--------------------------------------	-----------------------

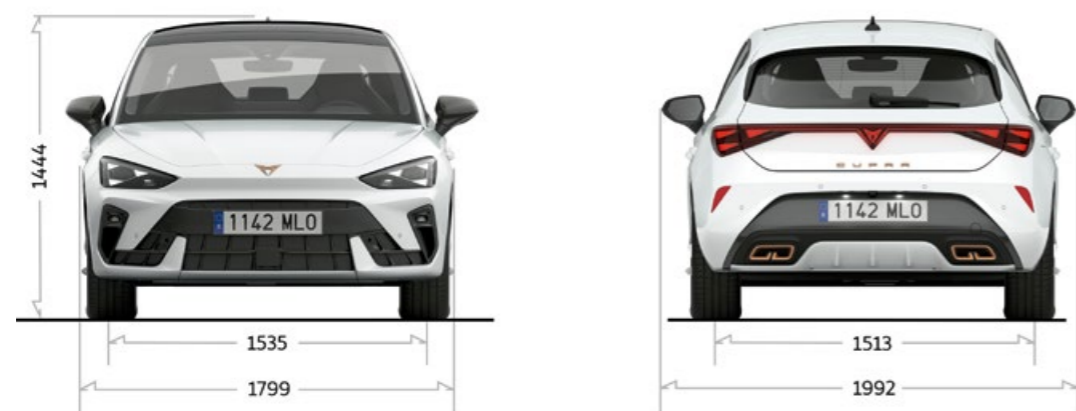

ENGINE SPECS

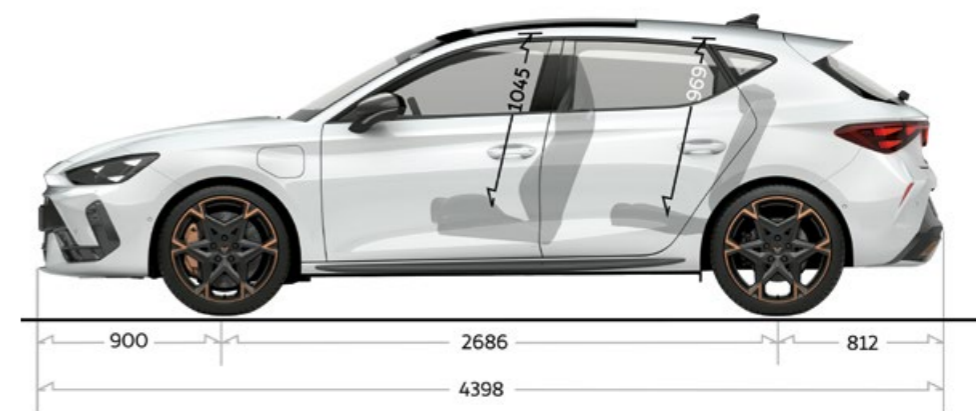

CHASSIS

1.5 TSI 150 HP (110 KW) 6-SPEED MANUAL START/STOP
CUPRA LEON | CUPRA LEON SPORTSTOURER

Front suspension	Independent type McPherson - coil springs - hydraulic shock absorber DCC equipment (Adaptive chassis control)
Rear suspension	Semirigid axle, Multilink axle (with 19" Rims), coil springs and hydraulic shock absorber DCC equipment (Adaptive chassis control)

STEERING

Steering system	R-EPS (Rack Electric Power System); Progressive steering
Turning Circle Diameter (m)	10.8

BRAKES

Brake system	Dual hydraulic circuit and brake system diagonal split with electric brake booster
Front and rear brake type	Front ventilated disc brakes and rear solid disc brakes
Front brakes (mm)	288x25 (306x26 with DCC)
Rear brakes (mm)	272x10

WHEELS

1.5 TSI 150 HP (110 KW) 6-SPEED MANUAL START/STOP
CUPRA LEON | CUPRA LEON SPORTSTOURER

Rims	7.5Jx18 ET46; 8Jx19 ET49
Tyres	225/40 R18; 235/35 R19



2024



ENGINE SPECS

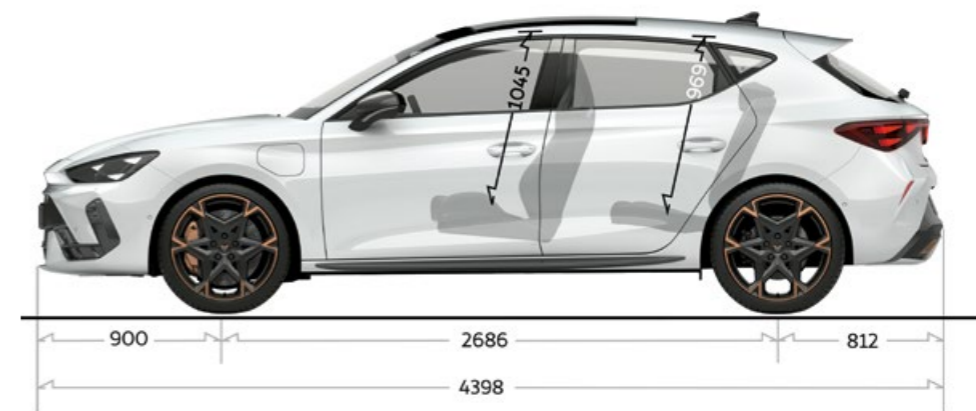

PACKAGE (IN RUNNING WITHOUT DRIVER)

1.5 TSI 150 HP (110 KW) 6-SPEED MANUAL START/STOP
CUPRA LEON | CUPRA LEON SPORTSTOURER

Body Type	CUPRA Leon CUPRA Leon Sportstourer
Length/width/height (mm)	4,398 / 1,799 / 1,444 4,656 / 1,799 / 1,438
Wheelbase (mm)	2686 (VL) - 2683 (ML)
Front/Rear track (mm)	1545 / 1514 1545 / 1514
Boot capacity (l)	380 620
Fuel tank capacity (l)	45 (VL) / 50 (ML)

WEIGHTS

1.5 TSI 150 HP (110 KW) 6-SPEED MANUAL START/STOP
CUPRA LEON | CUPRA LEON SPORTSTOURER

In running order with driver (kg)	1.373 - 1.409 1419 - 1.454
In running order with driver (kg) Front/Rear	834 / 539 - 839 / 570 818 / 601 - 823 / 631
Maximum weight allowed (kg)	1.860 - 1.880 1.940 - 1.970
Max. towing weight without brake (kg) (*)	680 - 700 700 - 720
Max. towing weight with brake 8% (kg)	1,700
Max. Towing weight with brake 12% (kg)	1,500



ENGINE SPECS CUPRA LEON AND SPORTSTOURER

PETROL ENGINE

2.0 TSI 300 HP (221 KW) DSG 7-SPEED START/STOP
CUPRA LEON VZ

Cylinder/Valve (Total)	4 / 16
Displacement (cc)	1.984
Cylinder bore and stroke (mm)	82,5 / 92,8
Compression ratio	9,3
Maximum power (kW (PS)/rpm)	221 (300) / 5300 - 6500
Maximum torque (Nm/rpm)	400 / 2000 - 5200
Fuel supply system	TSI Direct Injection
Ignition	Electronic map-controlled ignition
Atmospheric/Supercharged	Turbo charged
Fuel type	ROZ 95
Oil capacity in initial fill (l)	6.6
Alternator (A)	140A (8GU)
Battery (Ah/A)	70-68 / 420-380

ENGINE SPECS

PERFORMANCE

2.0 TSI 300 HP (221 KW) DSG 7-SPEED START/STOP
CUPRA LEON VZ

Maximum speed [km/h (gear)]	250 (V)
Acceleration 0-100 km/h (s)	5.7

FUEL CONSUMPTION

Combined WLTP (l/100)	7.5 - 7.9
-----------------------	-----------

MASS EMISSION

CO ₂ Combined WLTP (g/km)	171 - 179
--------------------------------------	-----------

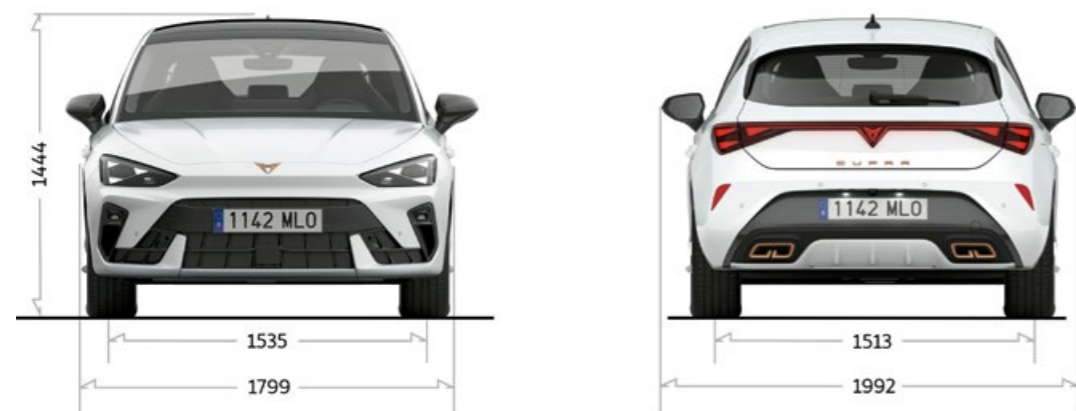

ENGINE SPECS

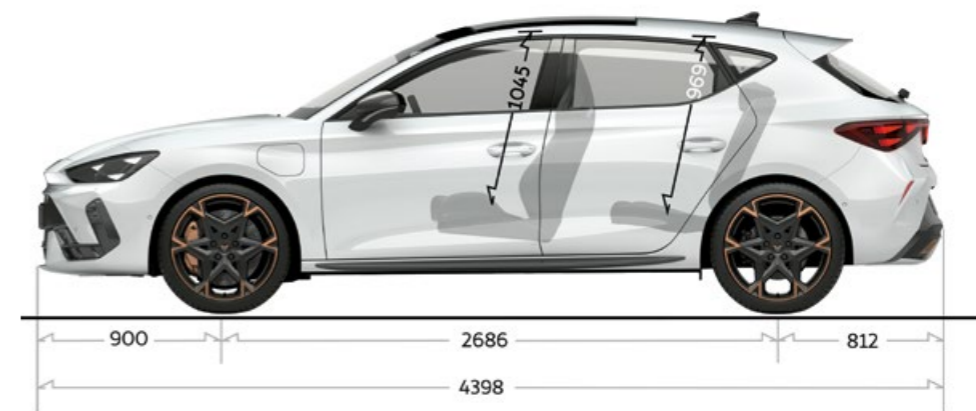

CHASSIS

2.0 TSI 300 HP (221 KW) DSG 7-SPEED START/STOP CUPRA LEON VZ

Front suspension	Independent type McPherson - coil springs - hydraulic shock absorber DCC equipment (Adaptive chassis control)
Rear suspension	Multilink axle, Coil springs and Hydraulic shock absorber DCC equipment (Adaptive chassis control)

STEERING

Steering system	R-EPS (Rack Electric Power System); Progressive steering
Turning Circle Diameter (m)	10.8

BRAKES

Brake system	Dual hydraulic circuit and brake system diagonal split with electric brake booster
Front and rear brake type	Front ventilated disc brakes and rear solid disc brakes
Front brakes (mm)	357×34 (375×36 with Performance Brakes)
Rear brakes (mm)	310×22

WHEELS

2.0 TSI 300 HP (221 KW) DSG 7-SPEED START/STOP CUPRA LEON VZ

Rims	7.5J×18 ET46; 8J×19 ET49; 8J×19 ET43
Tyres	225/40 R18; 235/35 R19



ENGINE SPECS

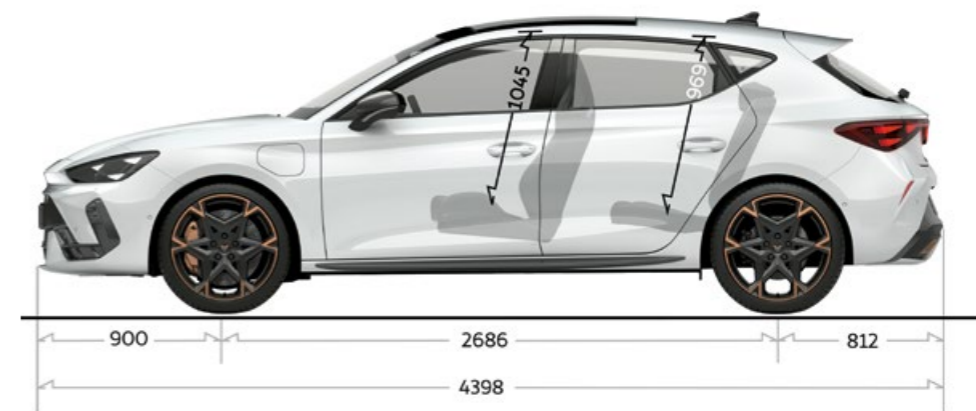

PACKAGE (IN RUNNING WITHOUT DRIVER)

2.0 TSI 300 HP (221 KW) DSG 7-SPEED START/STOP
CUPRA LEON VZ

Body Type	CUPRA Leon VZ
Length/width/height (mm)	4,398 / 1,799 / 1,444
Wheelbase (mm)	2686 (VL)
Front/Rear track (mm)	1540 / 1519
Boot capacity (l)	380
Fuel tank capacity (l)	50 (ML)

WEIGHTS

2.0 TSI 300 HP (221 KW) DSG 7-SPEED START/STOP
CUPRA LEON VZ

In running order with driver (kg)	1.496
In running order with driver (kg) Front/Rear	931 / 565
Maximum weight allowed (kg)	2.000
Max. towing weight without brake (kg) (*)	740
Max. towing weight with brake 8% (kg)	1.800
Max. Towing weight with brake 12% (kg)	1.600



ENGINE SPECS CUPRA LEON AND SPORTSTOURER

PETROL ENGINE

**2.0 TSI EVO 333 HP (245 KW) 4DRIVE DSG 7-SPEED START/STOP
CUPRA LEON SPORTSTOURER VZ**

Cylinder/Valve (Total)	4 / 16
Displacement (cc)	1.984
Cylinder bore and stroke (mm)	82,5 / 92,8
Compression ratio	9,3
Maximum power (kW (PS)/rpm)	245 (333) / 5600 - 6500
Maximum torque (Nm/rpm)	420 / 2100 - 5500
Fuel supply system	TSI Direct Injection
Ignition	Electronic map-controlled ignition
Atmospheric/Supercharged	Turbo charged
Fuel type	ROZ 95
Oil capacity in initial fill (l)	6.6
Alternator (A)	140A (8GU)
Battery (Ah/A)	70-68 / 420-380

ENGINE SPECS

PERFORMANCE

**2.0 TSI EVO 333 HP (245 KW) 4DRIVE DSG 7-SPEED START/STOP
CUPRA LEON SPORTSTOURER VZ**

Maximum speed [km/h (gear)]	250 (V)
Acceleration 0-100 km/h (s)	4.8

FUEL CONSUMPTION

Combined WLTP (l/100)	8.2 - 8.7
-----------------------	-----------

MASS EMISSION

CO ₂ Combined WLTP (g/km)	187 - 198
--------------------------------------	-----------



ENGINE SPECS

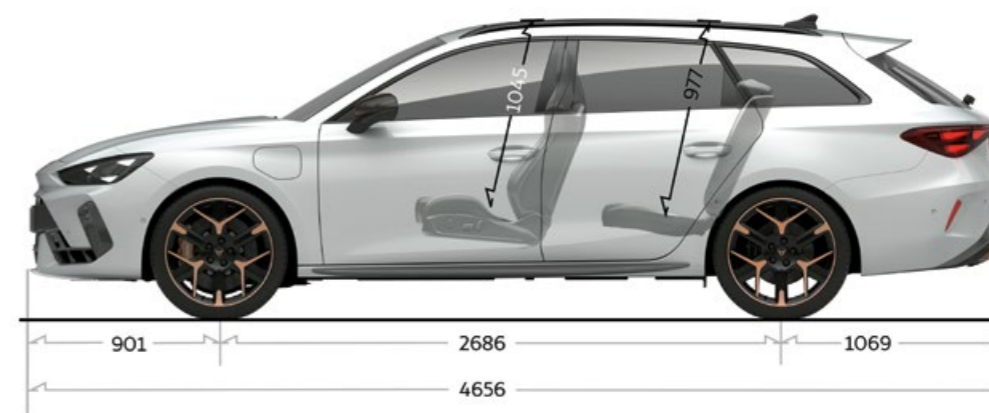

CHASSIS

2.0 TSI EVO 333 HP (245 KW) 4DRIVE DSG 7-SPEED START/STOP CUPRA LEON SPORTSTOURER VZ

Front suspension	Independent type McPherson - coil springs - hydraulic shock absorber DCC equipment (Adaptive chassis control)
Rear suspension	Multilink axle, Coil springs and Hydraulic shock absorber DCC equipment (Adaptive chassis control)

STEERING

Steering system	R-EPS (Rack Electric Power System); Progressive steering
Turning Circle Diameter (m)	10.8

BRAKES

Brake system	Dual hydraulic circuit and brake system diagonal split with electric brake booster
Front and rear brake type	Front ventilated disc brakes and rear solid disc brakes
Front brakes (mm)	357×34 (375×36 with Performance Brakes)
Rear brakes (mm)	310×22

WHEELS

2.0 TSI EVO 333 HP (245 KW) 4DRIVE DSG 7-SPEED START/STOP CUPRA LEON SPORTSTOURER VZ

Rims	7,5J×18 ET46; 8J×19 ET49; 8J×19 ET43
Tyres	225/40 R18; 235/35 R19



2024



ENGINE SPECS

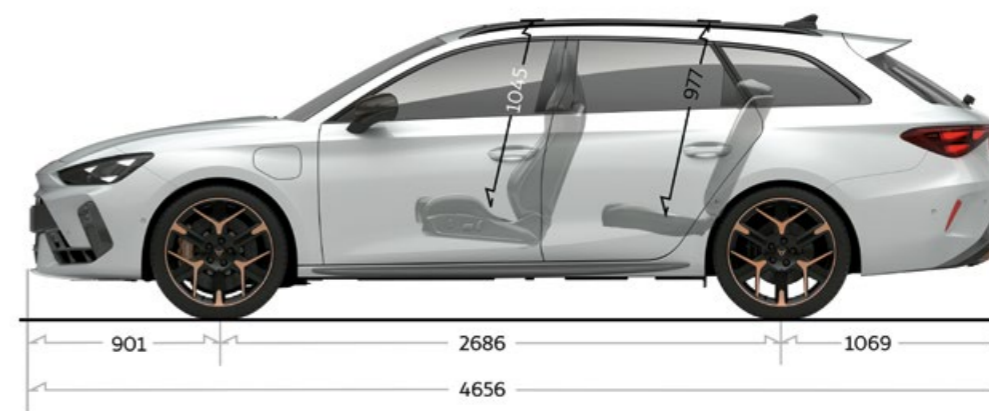

PACKAGE (IN RUNNING WITHOUT DRIVER)

2.0 TSI EVO 333 HP (245 KW) 4DRIVE DSG 7-SPEED START/STOP
CUPRA LEON SPORTSTOURER VZ

Body Type	CUPRA Leon Sportstourer VZ
Length/width/height (mm)	4,659 / 1,799 / 1,439
Wheelbase (mm)	2689 (VL)
Front/Rear track (mm)	1535 / 1511
Boot capacity (l)	620
Fuel tank capacity (l)	55 (ML)

WEIGHTS

2.0 TSI EVO 333 HP (245 KW) 4DRIVE DSG 7-SPEED START/STOP
CUPRA LEON SPORTSTOURER VZ

In running order with driver (kg)	1,651
In running order with driver (kg) Front/Rear	950 / 701
Maximum weight allowed (kg)	2,150
Max. towing weight without brake (kg) (*)	750
Max. towing weight with brake 8% (kg)	1,900
Max. Towing weight with brake 12% (kg)	1,700



ENGINE SPECS CUPRA LEON AND SPORTSTOURER

ENGINE SPECS

DIESEL ENGINE

2.0 TDI EVO 150 HP (110 KW) DSG-7 START/STOP
CUPRA LEON | CUPRA LEON SPORTSTOURER

Cylinder/Valve (Total)	4/16
Displacement (cc)	1.968
Cylinder bore and stroke (mm)	81,0 / 95,5
Compression ratio	16
Maximum power (kW (PS)/rpm)	110 (150) / 3000-4200
Maximum torque (Nm/rpm)	360 / 1600-2750
Fuel supply system	Direct Injection: Common Rail
Ignition	Compressed ignition
Atmospheric/Supercharged	Turbo charged
Fuel type	DIESEL
Oil capacity in initial fill (l)	6.0
Alternator (A)	140A (8GU)
Battery (Ah/A)	70Ah (420A) / 68Ah (380A)

PERFORMANCE

2.0 TDI EVO 150 HP (110 KW) DSG-7 START/STOP
CUPRA LEON | CUPRA LEON SPORTSTOURER

Maximum speed [km/h (gear)]	213 (6.G) 214 (6.G)
Acceleration 0-100 km/h (s)	8.5 8.7

FUEL CONSUMPTION

Combined WLTP (l/100)	4.8 - 5.1 4.9 - 5.2
-----------------------	-----------------------

MASS EMISSION

CO ₂ Combined WLTP (g/km)	126 - 135 128 - 138
--------------------------------------	-----------------------



ENGINE SPECS

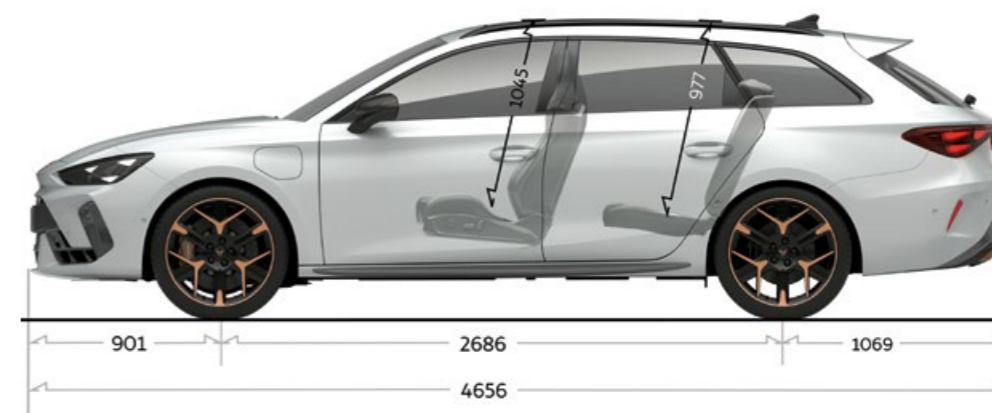

CHASSIS

2.0 TDI EVO 150 HP (110 KW) DSG-7 START/STOP
CUPRA LEON | CUPRA LEON SPORTSTOURER

Front suspension	Independent type McPherson - coil springs - hydraulic shock absorber DCC equipment (Adaptive chassis control)
Rear suspension	Semirigid axle, coil springs and hydraulic shock absorber - DCC equipment (Adaptive chassis control)

STEERING

Steering system	R-EPS (Rack Electric Power System); Progressive steering
Turning Circle Diameter (m)	10.8

BRAKES

Brake system	Dual hydraulic circuit and brake system diagonal split with brake booster
Front and rear brake type	Front ventilated disc brakes and rear solid disc brakes
Front brakes (mm)	288×25 (306×26 with DCC) 306×26
Rear brakes (mm)	272×10

WHEELS

2.0 TDI EVO 150 HP (110 KW) DSG-7 START/STOP
CUPRA LEON | CUPRA LEON SPORTSTOURER

Rims	7,5J×18 ET46; 8J×19 ET49
Tyres	225/40 R18; 235/35 R19



2024



ENGINE SPECS

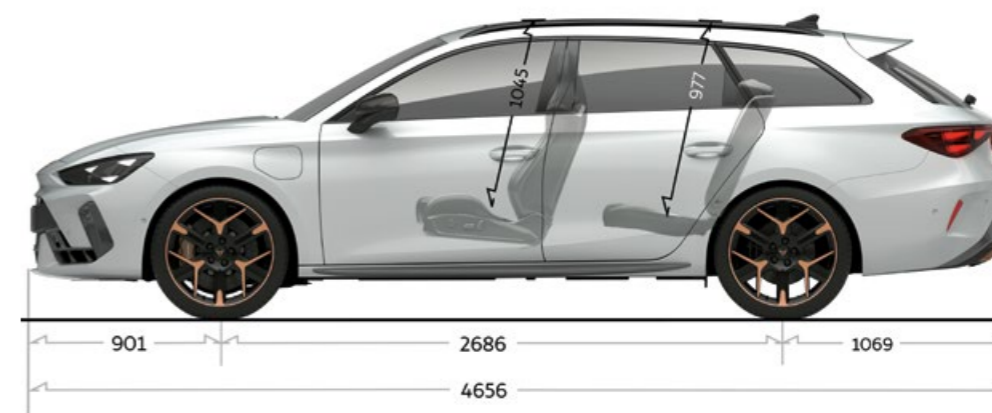

PACKAGE (IN RUNNING WITHOUT DRIVER)

2.0 TDI EVO 150 HP (110 KW) DSG-7 START/STOP
CUPRA LEON | CUPRA LEON SPORTSTOURER

Body Type	CUPRA Leon CUPRA Leon Sportstourer
Length/width/height (mm)	4398 / 1799 / 1444 4656 / 1799 / 1438
Wheelbase (mm)	2.686
Front/Rear track (mm)	1545 / 1514
Boot capacity (l)	380 620
Fuel tank capacity (l)	45

WEIGHTS

2.0 TDI EVO 150 HP (110 KW) DSG-7 START/STOP
CUPRA LEON | CUPRA LEON SPORTSTOURER

In running order with driver (kg)	1.479 1.524
In running order with driver (kg) Front/Rear	935 / 544 919 / 605
Maximum weight allowed (kg)	1.960 2.050
Max. towing weight without brake (kg) (*)	730 750
Max. towing weight with brake 8% (kg)	1.800
Max. Towing weight with brake 12% (kg)	1.600



ENGINE SPECS CUPRA LEON AND SPORTSTOURER

e-HYBRID ENGINE

1.5 e-HYBRID 272 HP (200 KW) DSG-6 START/STOP
CUPRA LEON VZ | CUPRA LEON SPORTSTOURER VZ

Cylinder/Valve (Total)	4 / 16
Displacement (cc)	1.498
Cylinder bore and stroke (mm)	74.5 / 85,9
Compression ratio	11.5
Maximum power (kW (PS)/rpm)	130 (177) / 5,500 – 6,000
Maximum torque (Nm/rpm)	250 / 1,550 – 4,000
Fuel supply system	TSI Direct Injection
Ignition	Electronic map-controlled ignition
Atmospheric/Supercharged	Turbo charged
Fuel type	ROZ 95
Oil capacity in initial fill (l)	4.8
Battery (Ah/A)	59 / 380

ENGINE SPECS

ELECTRIC ENGINE / CHARGING SYSTEM

1.5 e-HYBRID 272 HP (200 KW) DSG-6 START/STOP
CUPRA LEON VZ | CUPRA LEON SPORTSTOURER VZ

Maximum power (kW (PS))	85 (116)
Maximum torque (Nm)	330
Battery type	NMC
Number of cells	96
Nominal Pack Voltage (V)	353
Maximal Pack Voltage (V)	408
Battery capacity (kWh)	25.8
Charging time AC 11 kW 0-100% SoC min	150
Charging time DC up to 50 kW 10-80% SoC min	26

SYSTEM

Max. power (kW (PS))	200 (272)
Max. torque (Nm)	400

PERFORMANCE

Maximum speed [km/h]	229 [5.G]
Acceleration 0-80 km/h (s)	5.3 5.5
Acceleration 0-100 km/h (s)	7.1 7.3
Acceleration 80-120 km/h (s) in max. speed gear	7.4 7.6
Acceleration 0-1000 m (s)	28.3 28.6

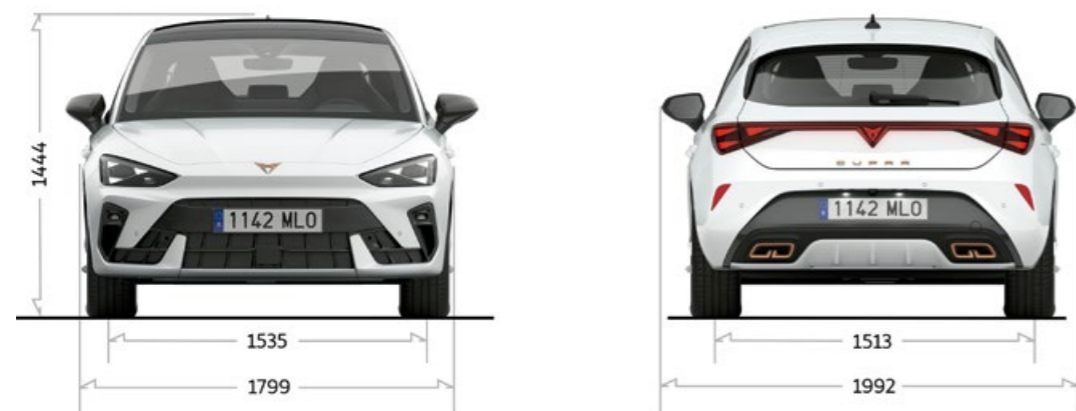

ENGINE SPECS

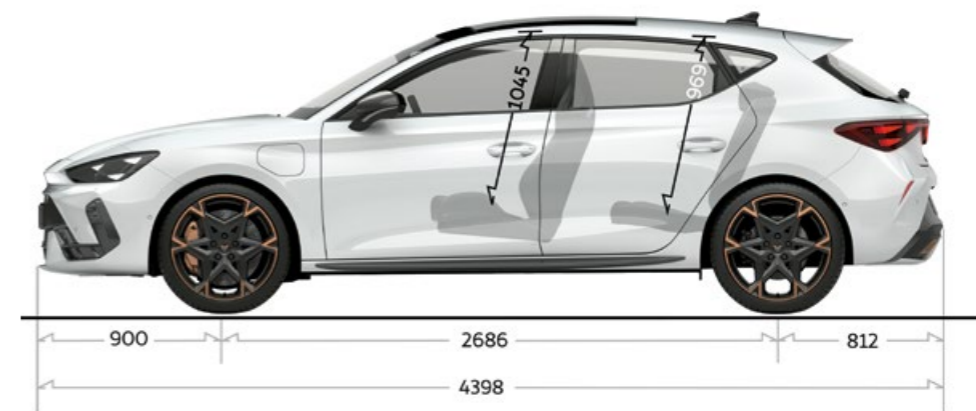

FUEL CONSUMPTION

1.5 e-HYBRID 272 HP (200 KW) DSG-6 START/STOP
CUPRA LEON VZ | CUPRA LEON SPORTSTOURER VZ

Charge sustaining mode WLTP (l/100)	5.4 - 5.5 5.5 - 5.6
Combined WLTP (l/100)	0.4 0.4 - 0.5

ELECTRIC CONSUMPTION

Electric consumption combined WLTP (kWh/100km)	16.5 - 16.9 16.6 - 17.1
Electric range WLTP (km)	125 - 121 124 - 120
Total range WLTP (km)	860 - 840 850 - 830

CHASSIS

1.5 e-HYBRID 272 HP (200 KW) DSG-6 START/STOP
CUPRA LEON VZ | CUPRA LEON SPORTSTOURER VZ

Front suspension	Independent type McPherson - coil springs - hydraulic shock absorber[DCC equipment (Adaptive chassis control)]
Rear suspension	Multilink axle, coil springs and hydraulic shock absorber DCC equipment (Adaptive chassis control)
Steering System	R-EPS (Rack Electric Power System); Progressive steering
Turning diameter (m)	10.8
Brake system	Dual hydraulic circuit and brake system diagonal split with brake booster
Front and rear brake type	Front and rear ventilated disc brakes
Front brakes (mm)	CUPRA brakes: 340x30 Performance brakes: 370x32
Rear brakes (mm)	310x22

WHEELS

Rims	7.5Jx18 ET46; 8Jx19 ET49; 8Jx19 ET43
Tyres	225/40 R18; 235/35 R19



2024

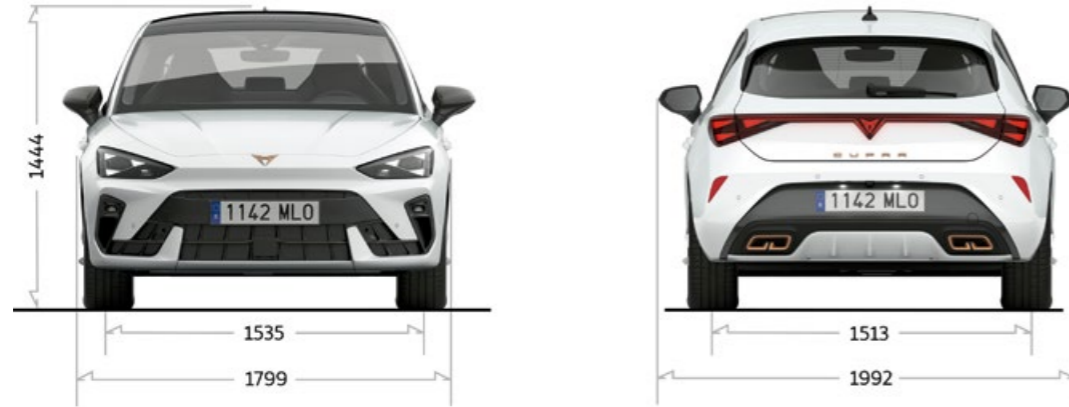

PACKAGE (IN RUNNING WITHOUT DRIVER)

1.5 e-HYBRID 272 HP (200 KW) DSG-6 START/STOP
CUPRA LEON VZ | CUPRA LEON SPORTSTOURER VZ

Body Type	CUPRA Leon VZ e-HYBRID CUPRA Leon Sportstourer VZ e-HYBRID
Length/width/height (mm)	4,399 / 1,799 / 1,441 4,657 / 1,799 / 1,441
Wheelbase (mm)	2,682
Front/Rear track (mm)	1,545 / 1,519 1,564 / 1,519
Boot capacity (l)	270 470
Fuel tank capacity (l)	40

ENGINE SPECS

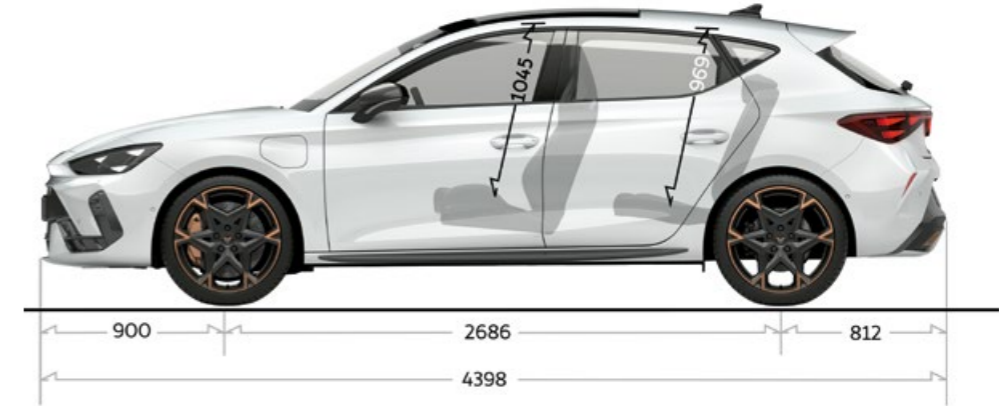

WEIGHTS

1.5 e-HYBRID 272 HP (200 KW) DSG-6 START/STOP
CUPRA LEON VZ | CUPRA LEON SPORTSTOURER VZ

In running order with driver (kg)	1,708 1,756
In running order with driver (kg) Front/Rear	950 / 758 934 / 822
Maximum weight allowed (kg)	2,140 2,150
Max. towing weight without brake (kg) (*)	- 750
Max. towing weight with brake 8% (kg)	- 1.700
Max. Towing weight with brake 12% (kg)	- 1.700



ENGINE SPECS CUPRA LEON AND SPORTSTOURER

e-HYBRID ENGINE

1.5 e-HYBRID 204 HP (150 KW) DSG-6
CUPRA LEON | CUPRA LEON SPORTSTOURER

Cylinder/Valve (Total)	4 / 16
Displacement (cc)	1498
Cylinder bore and stroke (mm)	74.5 / 85,9
Compression ratio	11.5
Maximum power (kW (PS)/rpm)	110 (150) / 5000 - 6000
Maximum torque (Nm/rpm)	250 / 1500 - 4000
Fuel supply system	TSI Direct Injection
Ignition	Electronic map-controlled ignition
Atmospheric/Supercharged	Turbo charged
Fuel type	ROZ 95
Oil capacity in initial fill (l)	4.8
Battery (Ah/A)	59 / 380

ENGINE SPECS

ELECTRIC ENGINE / CHARGING SYSTEM

1.5 e-HYBRID 204 HP (150 KW) DSG-6
CUPRA LEON | CUPRA LEON SPORTSTOURER

Maximum power (kW (PS))	85 (116)
Maximum torque (Nm)	330
Battery type	NMC
Number of cells	96
Nominal Pack Voltage (V)	353
Maximal Pack Voltage (V)	408
Battery capacity (kWh)	25.8
Charging time AC 11 kW 0-100% SoC min	150
Charging time DC up to 50 kW 10-80% SoC min	26

SYSTEM

Max. power (kW (PS))	150 (204)
Max. torque (Nm)	350

PERFORMANCE

Maximum speed [km/h]	220 [5.G]
Acceleration 0-80 km/h (s)	5.5 5.7
Acceleration 0-100 km/h (s)	7.7 7.9
Acceleration 80-120 km/h (s) in max. speed gear	8.2 8.4
Acceleration 0-1000 m (s)	28.5 28.7



ENGINE SPECS

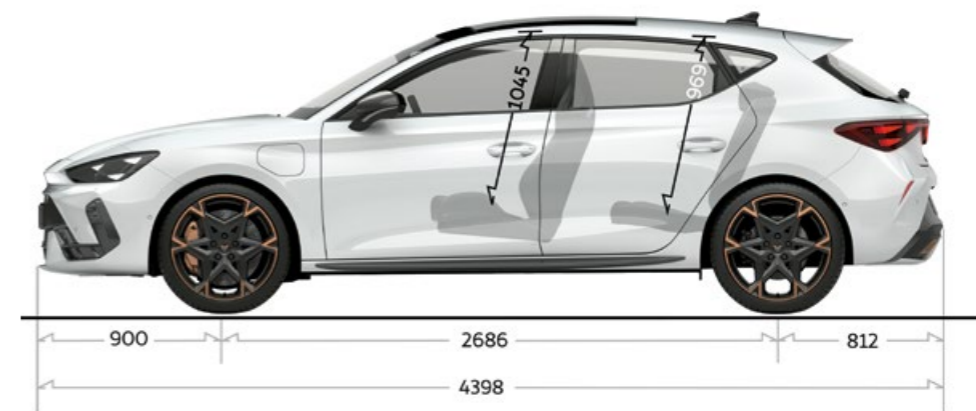

FUEL CONSUMPTION

1.5 e-HYBRID 204 HP (150 KW) DSG-6
CUPRA LEON | CUPRA LEON SPORTSTOURER

Charge sustaining mode WLTP (l/100)	5.1 - 5.5 5.2 - 5.6
Combined WLTP (l/100)	0.4 0.4

ELECTRIC CONSUMPTION

Electric consumption combined WLTP (kWh/100km)	15.7 - 16.5 15.8 - 16.8
Electric range WLTP (km)	133 - 125 131 - 123
Total range WLTP (km)	910 - 850 900 - 850

CHASSIS

1.5 e-HYBRID 204 HP (150 KW) DSG-6
CUPRA LEON | CUPRA LEON SPORTSTOURER

Front suspension	Independent type McPherson - coil springs - hydraulic shock absorber[DCC equipment (Adaptive chassis control)]
Rear suspension	Multilink axle, coil springs and hydraulic shock absorber DCC equipment (Adaptive chassis control)
Steering System	R-EPS (Rack Electric Power System); Progressive steering
Turning diameter (m)	10.8
Brake system	Dual hydraulic circuit and brake system diagonal split with brake booster
Front and rear brake type	Front and rear ventilated disc brakes
Front brakes (mm)	CUPRA brakes: 340x30 Performance brakes: 370x32
Rear brakes (mm)	310x22

WHEELS

Rims	7,5Jx18 ET46; 8Jx19 ET49; 8Jx19 ET43
Tyres	225/40 R18; 235/35 R19

Our global range of cars and product specifications varies from country to country. Please, visit your local CUPRA website to know more about the product offer available for you.



2024

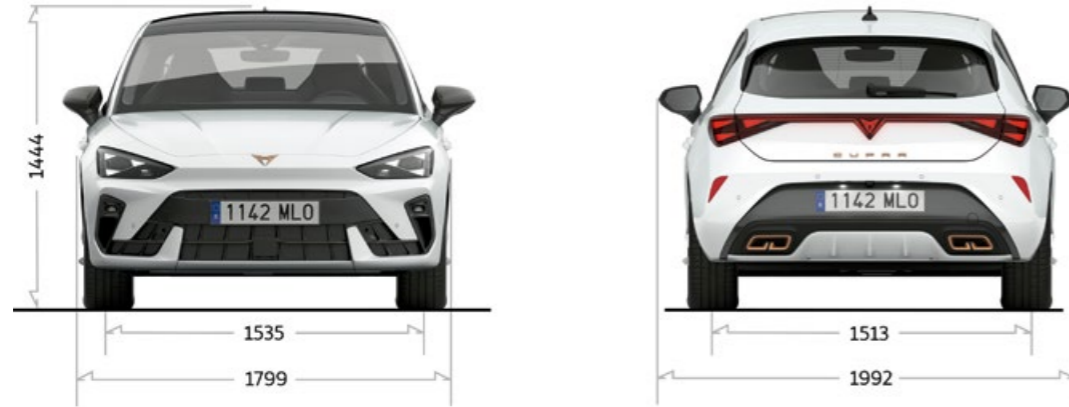

PACKAGE (IN RUNNING WITHOUT DRIVER)

1.5 e-HYBRID 204 HP (150 KW) DSG-6
CUPRA LEON | CUPRA LEON SPORTSTOURER

Body Type	CUPRA Leon VZ e-HYBRID CUPRA Leon Sportstourer VZ e-HYBRID
Length/width/height (mm)	4,399 / 1,799 / 1,441 4,657 / 1,799 / 1,441
Wheelbase (mm)	2,682
Front/Rear track (mm)	1,545 / 1,519 1,564 / 1,519
Boot capacity (l)	270 470
Fuel tank capacity (l)	40

ENGINE SPECS

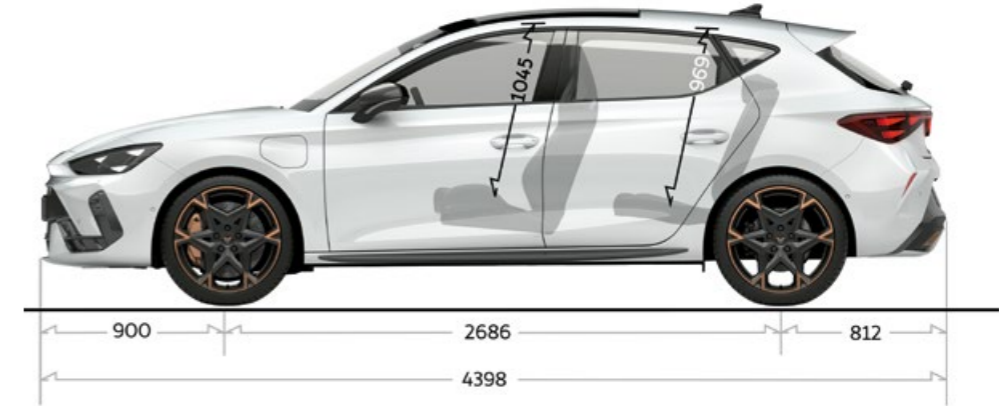

WEIGHTS

1.5 e-HYBRID 204 HP (150 KW) DSG-6
CUPRA LEON | CUPRA LEON SPORTSTOURER

In running order with driver (kg)	1,673 1,720
In running order with driver (kg) Front/Rear	932 / 741 915 / 805
Maximum weight allowed (kg)	2,130 2,140
Max. towing weight without brake (kg) (*)	- 750
Max. towing weight with brake 8% (kg)	- 1.700
Max. Towing weight with brake 12% (kg)	- 1.700



CUPRA is committed to a policy of continuous product development and reserves the right to make changes to specifications, colours and prices without notice. The information in this brochure can therefore be given as guidance only. While CUPRA makes every effort to ensure that specifications are accurate at the time of publication, you should always check with your authorised CUPRA Partner for the latest information. Due to limitations of the printing process the colours reproduced in this brochure may vary slightly from the actual paint colour and material — 01/2025.

Printed in Spain.